



Sprinter

Fuse assignment supplement



Symbols	2
----------------------	----------

Fuse/relay assignment diagram	3
--	----------

Notes on electrical fuses	3
---------------------------------	---

Fuses/relays in the front-passenger footwell	4
---	---

Fuses on the outside of the driver's seat base	8
---	---

Fuses/relays in the base of the driv- er's seat and in the battery box	11
---	----

Index	14
--------------------	-----------

In these Operating Instructions, you will find the following symbols:

 **DANGER** Danger due to not observing the warning notices

Warning notices draw your attention to hazards that may endanger your health or life, or the health or life of others.

► Observe the warning notices.

 **ENVIRONMENTAL NOTE** Environmental damage due to failure to observe environmental notes

Environmental notes include information on environmentally responsible behavior or environmentally responsible disposal.

► Observe environmental notes.

 **NOTE** Damage to property due to failure to observe notes on material damage

Notes on material damage inform you of risks which may lead to your vehicle being damaged.

► Observe notes on material damage.

 These symbols indicate useful instructions or further information that could be helpful to you.

 Instructions

(→ Further information on a topic page)

Display Display in the multifunction display/media display

Display in the taximeter

 Highest menu level to be selected in the multimedia system

 Corresponding submenus to be selected in the multimedia system

* Indicates a cause

Notes on electrical fuses

⚠ WARNING Risk of accident and injury due to overloaded lines

If you manipulate or bridge a faulty fuse or if you replace it with a fuse with a higher amperage, the electric line could be overloaded.

This could result in a fire.

- ▶ Always replace faulty fuses with specified new fuses containing the correct amperage.

! NOTE Damage due to incorrect fuses

Electrical components or systems could be damaged by incorrect fuses.

- ▶ Only use fuses which have been approved by Mercedes-Benz and which have the correct fuse rating.

The electrical fuses in your vehicle switch off defective circuits. If a fuse blows, all the components on the circuit and their functions will cease to operate.

Blown fuses must be replaced with fuses of an equivalent specification, which you can determine by the color and fuse rating. The fuse allocation chart and further information on the electric fuses and relays can be found in the "Fuse allocation chart" supplement.

! NOTE Damage or malfunctions caused by moisture

Moisture may cause damage to the electrical system or cause it to malfunction.

- ▶ When the fuse box is open, make sure that no moisture can enter the fuse box.
- ▶ When closing the fuse box, make sure that the seal of the lid is positioned correctly on the fuse box.

If the new fuse which has been inserted also blows, have the cause traced and rectified at a qualified specialist workshop.

Make sure of the following before replacing a fuse:

- the vehicle is secured such that it does not roll away
- all electrical consumers are switched off
- the ignition is switched off

The fuses are located in various fuse boxes:

- fuse box in the front-passenger footwell
- fuse box in the seat base of the driver's seat

Fuses/relays in the front-passenger footwell

Fuse assignment

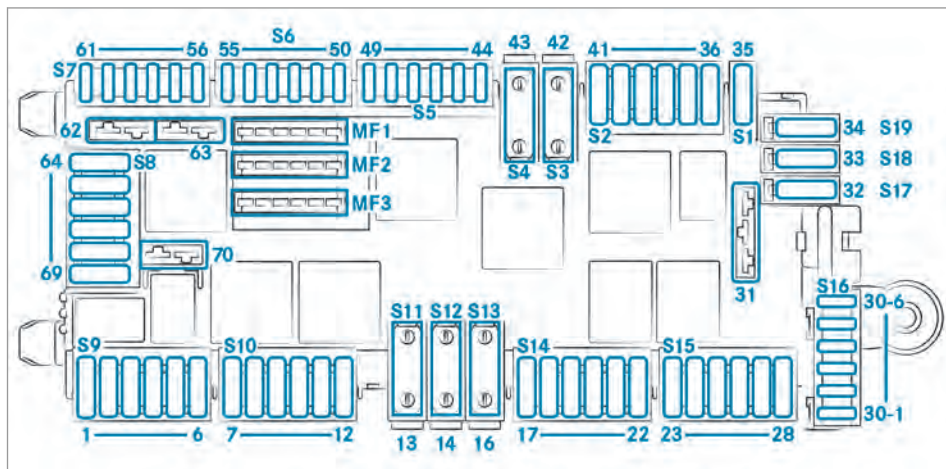

No.	Consumer	Fuse rating
MF1		
15-2	Engine control unit	5 A
15-2	Common Powertrain Module (CPC)	5 A
15-2	ESP® control unit	5 A
15-2	All-wheel drive control unit	5 A
15-2	Onboard Logistic Unit control unit	5 A
15-2	Terminal 15, special signal, cockpit body manufacturer	5 A
MF2		
15-1	Feedback cable, terminal 15 relay	5 A
15-1	Headlamp range adjustment, halogen headlamps	5 A
15-1	Tachograph TCO	5 A
15-1	Active Brake Assist radar sensor	5 A

No.	Consumer	Fuse rating
15-1	Deactivation of reverse warning device, power take-off, working speed control	5 A
15-1	DIN slot connection	5 A
MF3		
30-T	Multifunction camera	7.5 A
30-T	Unassigned	
30-T	DIN slot connection, roof	7.5 A
30-T	Terminal 30T, special signal, cockpit body manufacturer	7.5 A
30-T	Instrument cluster	7.5 A
30-T	DIN slot, cockpit	7.5 A
S9		
1	Unassigned	
2	Common Powertrain Module (CPC)	10 A
3	Engine control unit OM642/OM651/M274	10 A

No.	Consumer	Fuse rating
	Engine control unit OM654	5 A
4	Automatic transmission central oil pump	7.5 A
5	Common Powertrain Module (CPC)	10 A
6	Engine radiator fan	5 A
S10		
7	Automatic transmission servo module	30 A
8	Body controller	30 A
9	Body controller	30 A
10	Heating, SCR catalytic converter	30 A
11	Overhead control panel (standard)	10 A
	Overhead control panel, Cab Chassis	10 A
	Overhead control panel (high)	15 A
12	Pump, SCR catalytic converter	15 A
S11		
13	Automatic transmission	60 A
S12		
14	ESP® valves (Premium), vehicles with electric parking brake	40 A
	ESP® valves (Standard)	25 A
S13		
16	ESP® pump	60 A
S14		
17	Body controller	30 A
18	Body controller	30 A

No.	Consumer	Fuse rating
19	Terminal strip for body manufacturer electrical connection	10 A
20	Co-driver door control unit	25 A
21	Driver's door control unit	25 A
22	Air suspension (LFA) control unit	10 A
S15		
23	Unassigned	
24	USB charging socket (cockpit), USB charging socket (stowage compartment), 115 V/230 V converter socket	7.5 A
25	Cigarette lighter	15 A
	Socket, center console	15 A
26	Information panel socket	15 A
27	Converter socket, 115 V/230 V	25 A
28	Radio pre-installation, cargo liftgate, DSP connecting point, antenna voltage converter, 115/230V converter socket for vehicles with auxiliary battery	7.5 A
S16		
30-1	Unassigned	
30-2	Tachograph TCO	7.5 A
30-3	Central locking	5 A
30-4	Anti-theft alarm system (ATA)	5 A
30-5	Unassigned	
30-6	Electronic ignition lock control unit	10 A
31-A	Unassigned	
31-B	Starter power supply, relay	25 A

No.	Consumer	Fuse rating
S17		
32	Unassigned	
S18		
33	Voltage dip limiter (SEB)	5 A
S19		
34	Electrics for body interior lighting	10 A
S1		
35	Ventilation blower regulator	30 A
S2		
36	Air conditioning control panel	5 A
37	Electric Steering Wheel Locking (ESTL)	5 A
38	Steering Column Switch Module (SCSM)	10 A
39	Digital signal processor pre-installation	10 A
40	Rotating beacon	5 A
41	Radio multimedia system/radio pre-installation	25 A
S3		
42	Unassigned	
S4		
43	Unassigned	
S5		
44	Multimedia system control panel	5 A
45	Mobile phone cradle (WMI)	5 A
46	Multimedia connection unit (MMI)	7.5 A
47	Hermes (LTE communication module)	5 A
48	Telestart stationary heating	5 A

No.	Consumer	Fuse rating
49	Central display	5 A
S6		
50	Additional headlamp, left (platform body manufacturer)	5 A
51	Additional headlamp, right (platform body manufacturer)	5 A
	Switch clock for the auxiliary heating air, terminal 15 relay	5 A
52	Control unit, airbag	7.5 A
53	Diagnostics	5 A
54	Relay supply	5 A
55	Engine connection point (diesel), engine control unit (OM651/OM642/M274)	7.5 A
S7		
56	Engine control unit (OM654)	15 A
57	Soot particulate sensor, NO _x sensor (OM654)	15 A
	Soot particulate sensor	10 A
58	Engine, exhaust gas recirculation (EGR) (OM642/OM651)	10 A
	Engine (M274/OM654)	15 A
59	NO _x sensor before/after catalytic converter	10 A
60	Lambda sensor	7.5 A
	Coolant pump (OM654)	15 A
61	Engine (M274/OM651)	10 A
	Engine (OM642)	7.5 A
	Engine (OM654)	5 A
H2		
62	Engine (M274)	15 A

No.	Consumer	Fuse rating
	Engine (OM651/OM642)	20 A
63	Engine (M274)	20 A
	Engine (OM651/OM642)	25 A
S8		
64	Body controller	30 A
65	Body controller	30 A
66	Automatic transmission auxiliary oil pump	15 A
67	Control unit for fuel measurement (FSCM)	25 A
68	LED headlamp, right	15 A
69	LED headlamp, left	15 A
H2		
70	Windshield wipers	30 A

Relays in the co-driver's footwell

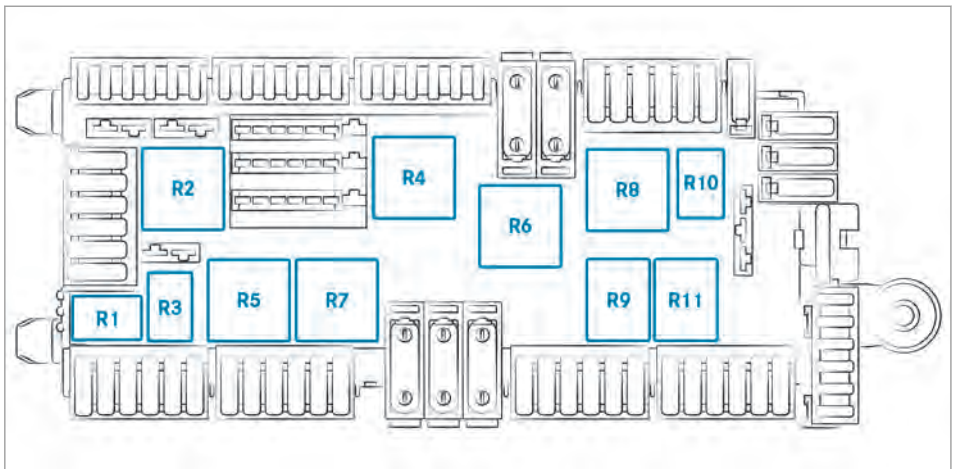

No.	Designation	Permissible current intensity
R1	Reserve	30 A
R2	Terminal 87, engine	50 A
R3	Terminal 87, Common Powertrain Module CPC	30 A
R4	Terminal 15	40 A
R5	Windshield wipers on/off	40 A
R6	Reserve	40 A
R7	Windshield wipers fast/slow	40 A
R8	Terminal 50, starter	40 A
R9	Terminal 15R (vehicles without auxiliary battery)	50 A
R10	Starter power supply, relay	30 A
R11	Terminal 15R (vehicles with auxiliary battery)	50 A

Fuses on the outside of the driver's seat base

Fuse assignment

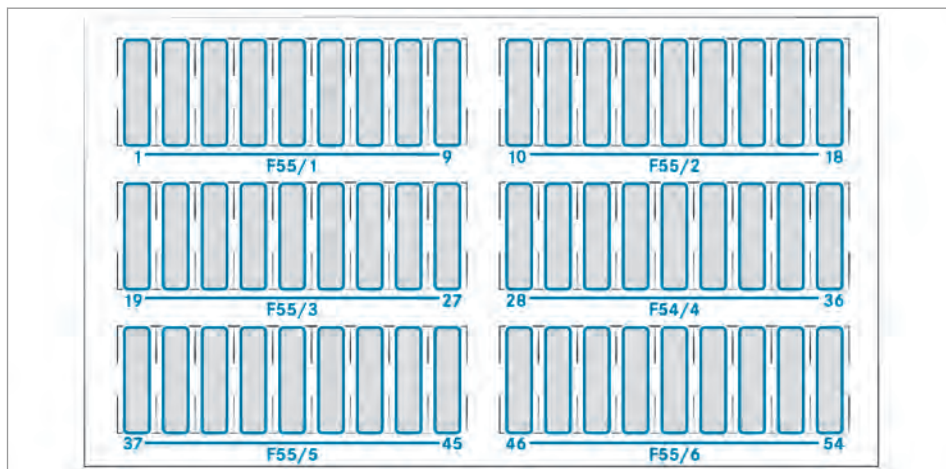

Fuse block F55/1

No.	Consumer	Fuse rating
1	Additional turn signal lamp	10 A
	Roof ventilator	15 A
2	Rear window wiper, right	15 A
3	All-wheel drive control unit	30 A
	4MATIC all-wheel drive control unit	30 A
4	Parking Package	5 A
	Rear view camera	
5	Driver seat adjustment control unit	25 A
	Driver's seat heating control unit	
6	Driver lumbar support	10 A
	Co-driver lumbar support	
7	Co-driver seat adjustment control unit	25 A
	Co-driver seat heating control unit (double jump seat)	
8	Tire pressure monitor control unit	5 A
	Motion detector and tire pressure monitor control unit	
9	Terminal 30, terminal strip for body manufacturer's electrical connection	25 A

Fuse block F55/2

No.	Consumer	Fuse rating
10	Trailer coupling control unit, right	25 A
11	Trailer coupling control unit (socket)	15 A
12	Trailer coupling control unit, left	25 A

No.	Consumer	Fuse rating
13	Trailer coupling control unit (charging cable)	15 A
14	Parameterizable special module control unit	25 A
15	Parameterizable special module control unit	25 A
16	Rear blower	25 A
17	Hot-water auxiliary heater	20 A
18	Terminal 30T for terminal 15 relay	5 A

Fuse block F55/3

No.	Consumer	Fuse rating
19	Rear window heater, left	15 A
	Additional caravanning unit (PWM 1)	30 A
20	Rear window heater, right	15 A
	Additional caravanning unit (PWM 2)	30 A
21	Rear window heater relay	30 A
	Additional caravanning unit control unit	5 A
22	Trailer brake booster	30 A
23	Cargo liftgate/dumper vehicle (pre-installation)	7.5 A
	Roof ventilator	5 A
24	Terminal strip for electrical connection (body manufacturer)	15 A
25	Rear view camera for inside rearview mirror/rear view camera pre-installation	5 A
	Rear view camera display, inside rearview mirror	
26	Auxiliary warm-air heater	15 A

No.	Consumer	Fuse rating
	Terminal 30 relay to terminal 15 auxiliary battery	
27	Auxiliary battery voltage measurement	5 A

Fuse block F55/4

No.	Consumer	Fuse rating
28	Sliding door, left	15 A
	Electric sliding door, left	30 A
29	Sliding door, right	15 A
	Electric sliding door, right	30 A
30	Antenna switch box	5 A
31	Automatic transmission	7.5 A
32	Automatic transmission	10 A
33	On-Board Logistic Unit	30 A
34	Pre-installation for siren system	15 A
	Pre-installation for camper van	30 A
35	Rotating beacon with siren	15 A
	Pre-installation for camper van	30 A
36	Pre-installation for camper van	30 A

Fuse block F55/5

No.	Consumer	Fuse rating
37	Electrical step, left	10 A
38	Electrical step, right	10 A
39	Warning buzzer, electrical step, left/right	5 A
40	Automatic transmission	10 A

No.	Consumer	Fuse rating
41	Air spring	5 A
42	Retarder	5 A
43	Socket, cab	15 A
44	Socket, D-pillar, left	15 A
45	Socket, D-pillar, right	15 A

Fuse block F55/6

No.	Consumer	Fuse rating
51	USB charge socket, side wall, front left	7.5 A
	USB charge socket, side wall, front left (with sliding door, left)	5 A
52	USB charge socket, side wall, front right	7.5 A
	USB charge socket, side wall, front right (with sliding door, right)	5 A
53	USB charge socket, side wall, front left (bus)	7.5 A
	USB charge socket, side wall, front left (Passenger Van)	5 A
54	USB charge socket, side wall, front right (bus)	7.5 A
	USB charge socket, side wall, front right (Passenger Van)	5 A

Fuses/relays in the base of the driver's seat and in the battery box

Fuse assignment

Additional fuses and relays etc. are located in the seat base of the driver's seat:

- for the windshield heater
- for other vehicle components, such as power-steering pumps, auxiliary battery, battery cut-off relays and PTC heater boosters
- from the body manufacturers for retarders, cargo liftgate, hydraulic pump and dumper vehicle

i Always have the fuses and relays in the seat base replaced at a qualified specialist workshop.

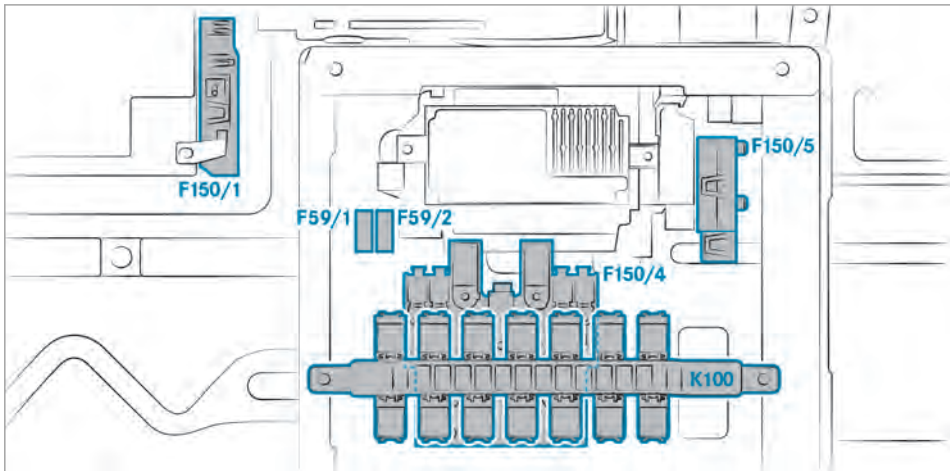

Fuse block F150/1 (MFB-1) in the battery box

No.	Consumer	Fuse rating
1	Battery sensor	
2	Unassigned	MIDI
3	Main fuse box (MFB-2)	Busbar
4	Power Distribution Center, terminal 30 (F30-1 – F30-6)	50 A
5	PTC heater booster	125 A

Fuse block F150/4 (MFB-2)

No.	Consumer	Fuse rating
1	Terminal 30T, fuse box, seat base of driver's seat (F55/1 - F55/6)	125 A
2	Electric steering	125 A
3	Alternator	300 A
	Alternator	400 A
4	Unassigned	
5	Power Distribution Center (PDC), FB-P	175 A
6	Glow output stage (GZE)	80 A

No.	Consumer	Fuse rating
7	Engine radiator fan	40 A
	Engine radiator fan	80 A
	Engine radiator fan	100 A
8	Camper van main fuses	100 A
9	Unassigned	
10	Air-conditioning system, rear	100 A
	Air-conditioning system, rear	50 A
	Air-conditioning system, rear	25 A
11	Auxiliary battery/battery cut-off relay	150 A
	Retarder without auxiliary battery	100 A
12	Air suspension (LFA)	40 A
13	Windshield heater	80 A

Fuse block F150/5 (MFB-ZB)

No.	Consumer	Fuse rating
1	Retarder	100 A
2	Cargo liftgate/dumper vehicle (pre-installation)	250 A
3	Auxiliary battery	
4	Battery cutoff relay	150 A
5	DC/AC converter sockets with auxiliary battery	60 A
6	Auxiliary warm-air heater with auxiliary battery	25 A
	Hot air auxiliary heater, supply for additional caravaning unit with auxiliary battery	80 A

Individual fuses F59/1 and F59/2

No.	Consumer	Fuse rating
1	Windshield heater, left	40 A
2	Windshield heater, right	40 A

K100 relay carrier

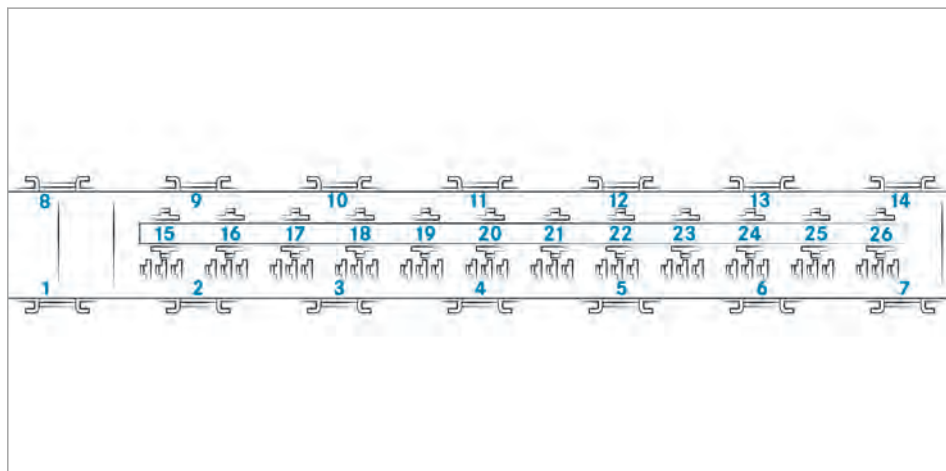

No.	Designation
Supplementary relay, bottom	
1	Windshield heater
2	Terminal 15
3	Rear window heater
4	Sockets, rear
5	Free
6	Free
7	Free
Supplementary relay, top	
8	Free
9	Free
10	Free
11	Free
12	Free
13	Free
14	Free
Mini-relay	
15	Rear window wiper, right

No.	Designation
16	Terminal strip body manufacturer
17	Switch, reverse warning device
18	Roof ventilator
	Interior lighting
19	Auxiliary oil pump
20	Electrical step, right 1
21	Electrical step, right 2
22	Electrical step, left 1
23	Electrical step, left 2
24	Siren
25	Rotating beacon with siren
26	Cargo liftgate
	Terminal 15 on auxiliary battery
Auxiliary battery relay	
	Auxiliary battery

E**Electrical fuses**

see Fuses

F

Fuses	3
Before replacing	3
Notes	3

Fuses on the outside of the driver's seat base

Fuse assignment	8
-----------------------	---

Fuses/relays in the base of the driver's seat and in the battery box

Fuse assignment	11
K100 relay carrier	13

Fuses/relays in the front-passenger footwell

Fuse allocation	4
Relay assignment	7

Publication details

Internet

Further information on Freightliner vans can be found at:

<https://www.freightlinersprinterusa.com>

Documentation team

©Mercedes-Benz AG: not to be reprinted, translated or otherwise reproduced, in whole or in part, without written permission from Mercedes-Benz AG.

Vehicle manufacturer

Mercedes-Benz AG
Mercedesstraße 120
70372 Stuttgart
Germany

Vehicle dealer

Daimler VANS USA, LLC

One Mercedes-Benz Drive
Sandy Springs, GA 30328
<https://www.mbusa.com> (USA only)
<https://www.freightlinersprinterusa.com>
Customer Assistance Center:
1-877-762-8267
Daimler VANS USA, LLC is a Daimler Company.



9075848305

Order no. T907 0206 13 Part no. 907 584 83 05 Edition 2019-12