

FREIGHTLINER



# Sprinter

Brief Instructions

## **Thank you for choosing the new Sprinter.**

Before your first journey, please familiarize yourself with your vehicle and how it operates, as well as its driving, control and convenience functions.

Before you drive off, read this Operator's Manual. This will help you to obtain the maximum pleasure from your vehicle and to avoid endangering yourself and others.

The equipment or product name for your vehicle may vary, depending on:

- model
- order
- country specification
- availability

Your vehicle's equipment may differ from some descriptions and illustrations. Items of optional equipment are also described in this manual, should you require a description of the way they work.

The manufacturer continuously updates its vehicles and equipment. We therefore reserve the right to make changes with regard to:

- design
- equipment
- technical features

Your nearest authorized Sprinter Dealer will be happy to assist you further if you have any other questions.

The Operator's Manual, Brief Instructions, Service and Warranty Information Booklet, Maintenance Booklet and equipment-related supplementary operator's manuals are integral parts of the vehicle.

Always keep these manuals in the vehicle. Pass them on to the new owner if you sell the vehicle.

We extend our best wishes for many miles of safe, pleasurable driving.

<b>At a glance</b> .....	<b>2</b>	Vehicle tool kit and emergency equipment .....	20
Cockpit .....	2	Warning triangle .....	20
Instrument cluster variants .....	4	Warning lamp .....	20
Steering wheel with buttons .....	6	First-aid kit .....	21
Center console .....	6	Spare wheel .....	21
Switch units .....	7	Tire sealant .....	22
Center console .....	7		
Roof .....	7		
Driver's door .....	8		
Additional switch units .....	8		
<b>Controls</b> .....	<b>10</b>		
Opening and closing .....	10		
Remote control with an integrated folding key .....	10		
Adjusting .....	10		
Ignition lock .....	10		
Seats .....	11		
Steering wheel .....	11		
Seat belts .....	12		
Lighting .....	12		
Light switch .....	12		
Turn signals .....	12		
Good visibility .....	13		
Windshield wipers .....	13		
Rear window wiper .....	13		
Climate control .....	14		
Overview of climate control systems .....	14		
Overview of the functions of the climate control system .....	15		
Driving .....	16		
Automatic transmission .....	16		
Parking brake .....	17		
<b>Operation</b> .....	<b>18</b>		
Refueling .....	18		
Diesel Exhaust Fluid (DEF) .....	18		
<b>Practical advice</b> .....	<b>20</b>		
Where will I find...? .....	20		

## Cockpit

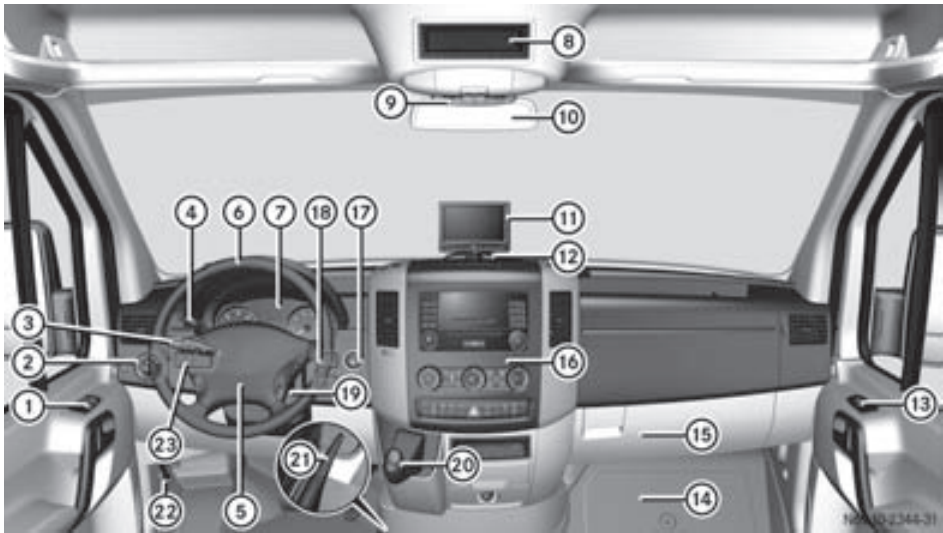

**i** This Operator's Manual describes all the standard and optional equipment available for your vehicle at the time of purchase. Country specific differences are possible. Please note that your vehicle might not be equipped with all the functions described here. This also includes safety relevant systems and functions.

	Function
①	Door control panel
②	Light switch
③	Combination switch: <ul style="list-style-type: none"> <li>• turn signals</li> <li>• high-beam headlamps</li> <li>• windshield wipers</li> <li>• rear window wiper</li> </ul>
④	Cruise control lever
⑤	Horn
⑥	Steering wheel without/with buttons

	Function
⑦	Instrument cluster
⑧	Stowage compartment
⑨	<ul style="list-style-type: none"> <li>• Stowage compartment with interior light</li> <li>• Overhead control panel</li> </ul>
⑩	Rear-view mirror
⑪	Rear-view camera monitor
⑫	PARKTRONIC warning display
⑬	Opens/closes the right-hand side window
⑭	Jack and vehicle tool kit
⑮	Glove box
⑯	Center console
⑰	Ignition lock
⑱	Additional switch unit
⑲	Steering wheel adjustment

**Warning!**

Make sure that you read the Operator's Manual. You may otherwise fail to recognize hazards.

	Function
⑳	Selector lever (automatic transmission)
㉑	Parking brake

	Function
㉒	Opens the hood
㉓	Additional switch unit



Make sure that you read the Operator's Manual. You may otherwise fail to recognize hazards.

Instrument cluster variants

At a glance

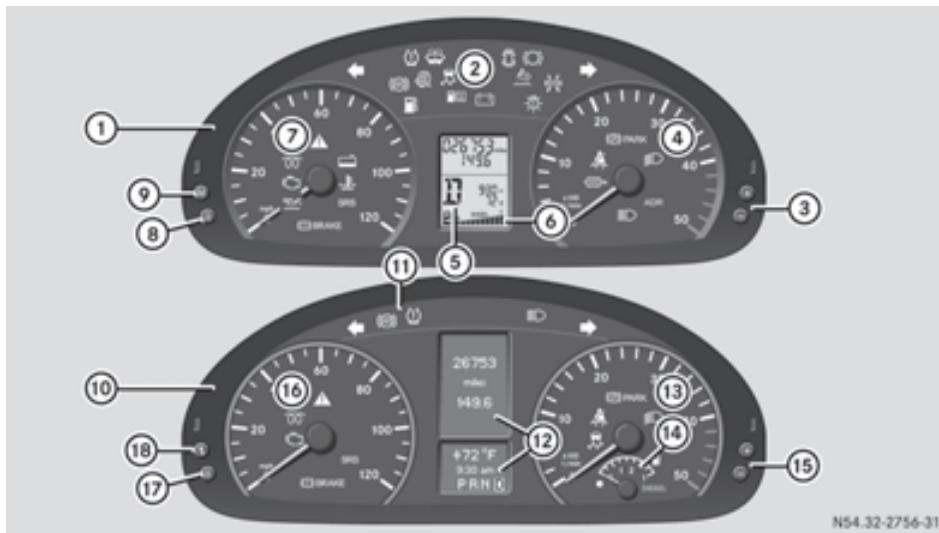



















N54.32-2756-31









	Function
①	<b>Instrument cluster on vehicles without steering-wheel buttons</b>
②	Indicator and warning lamps
③	⊕, ⊖ Brightens/dims the instrument cluster lighting
④	Tachometer with indicator and warning lamps
⑤	Display
⑥	Fuel gauge with fuel filler flap location indicator
⑦	Speedometer with indicator and warning lamps
⑧	Reset button ①
⑨	Ⓜ Menu button: <ul style="list-style-type: none"> <li>• changes standard display</li> <li>• selects menus</li> </ul>
⑩	<b>Instrument cluster on vehicles with steering-wheel buttons</b>

	Function
⑪	Indicator and warning lamps
⑫	Display
⑬	Tachometer with indicator and warning lamps
⑭	Fuel gauge with fuel filler flap location indicator
⑮	⊕, ⊖ Brightens/dims the instrument cluster lighting
⑯	Speedometer with indicator and warning lamps
⑰	Reset button ①
⑱	Ⓜ Service button Checks the engine oil level
	<b>Indicator and warning lamps</b>
	ESP® warning lamp ASR warning lamp
	Coolant level too low

**Warning!**

Make sure that you read the Operator's Manual. You may otherwise fail to recognize hazards.

	Function
	Coolant temperature too high
	Restraint systems malfunction
	Brake fluid level too low EBD malfunction Trailer brake force booster malfunction
	Engine oil level warning
	Check engine indicator lamp Exhaust gas aftertreatment malfunction
	Preglow system
	Left-hand turn signal
	Tire pressure loss or the tire pressure monitor is malfunctioning (USA only) Tire pressure loss (Canada only)
	Fluid level too low in windshield washer/headlamp cleaning system
	Door open
	Brake pads/linings worn
	Right-hand turn signal
	ABS malfunction
	ASR malfunction BAS malfunction
	ESP® malfunction
	DEF supply low or contaminated/ thinned Exhaust gas aftertreatment malfunction
	Dirt accumulation in air filter
	Reserve fuel Fuel filler cap open

	Function
	Water in the fuel
	Battery charging malfunction
	Bulb defective
	Parking brake applied
	Low-beam headlamps on
	Working speed governor (ADR) on
	High-beam headlamps on
	Reserve fuel Fuel filler cap open
	Fasten seat belt

- i** Vehicles with steering-wheel buttons:  
Corresponding messages may also be shown in display ⑫.



**Warning!**

Make sure that you read the Operator's Manual. You may otherwise fail to recognize hazards.

## Steering wheel with buttons

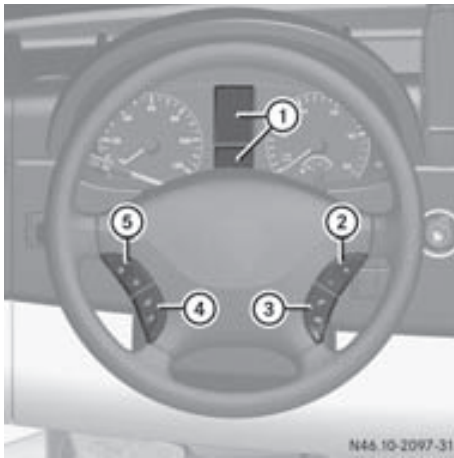

	Function
①	Display
	<b>Controls the on-board computer</b>
②	Selects a submenu or adjusts the volume <input type="checkbox"/> + Up/increases the volume <input type="checkbox"/> - Down/reduces the volume
③	Using the telephone <input type="checkbox"/> Accepts a call/starts dialing <input type="checkbox"/> Ends a call/rejects an incoming call
④	Scrolling from one menu to another <input type="checkbox"/> Forwards <input type="checkbox"/> Back
⑤	Scrolling from one submenu to another <input type="checkbox"/> Forwards <input type="checkbox"/> Back

## Center console



	Function
①	Stowage compartment
②	Radio; see the separate operating instructions
③	Air-conditioning control panel
④	Center console switch unit
⑤	<ul style="list-style-type: none"> <li>Stowage compartment or</li> <li>CD changer; see the separate operating instructions</li> </ul>
⑥	Cup holder with: <ul style="list-style-type: none"> <li>ashtray</li> <li>cigarette lighter</li> </ul>
⑦	12 V socket

**Warning!**

Make sure that you read the Operator's Manual. You may otherwise fail to recognize hazards.











## Switch units

## Center console



## Function

	Switches the left/right-hand seat heating on/off
	Switches the windshield heating on/off
	Switches the rear window defroster on/off
	Activates/deactivates PArkTRONIC
	Switches the hazard warning lamps on/off
	Activates/deactivates ASR
	Central locking, interior/rear compartment
	

## Roof

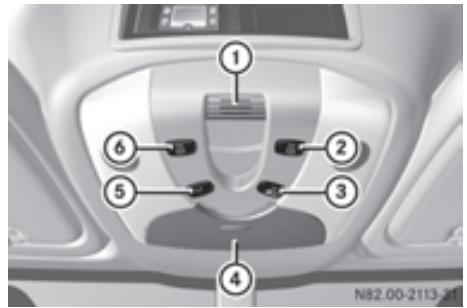

## Function

①	Microphone for the telephone
②	Switches the right-hand reading lamp on/off
③	Switches the automatic interior lighting on/off
④	<ul style="list-style-type: none"> <li>• Eyeglasses compartment or</li> <li>• Anti-theft alarm system (ATA)</li> </ul>
⑤	Switches the interior lighting on/off
⑥	Switches the left-hand reading lamp on/off



## Warning!

Make sure that you read the Operator's Manual. You may otherwise fail to recognize hazards.

## Driver's door

**Function**

- |   |   |
|---|---|
| ① | Adjusts the exterior mirrors            |
| ② | Selects an exterior mirror              |
| ③ | Opens/closes the left-hand side window  |
| ④ | Opens/closes the right-hand side window |

## Additional switch units

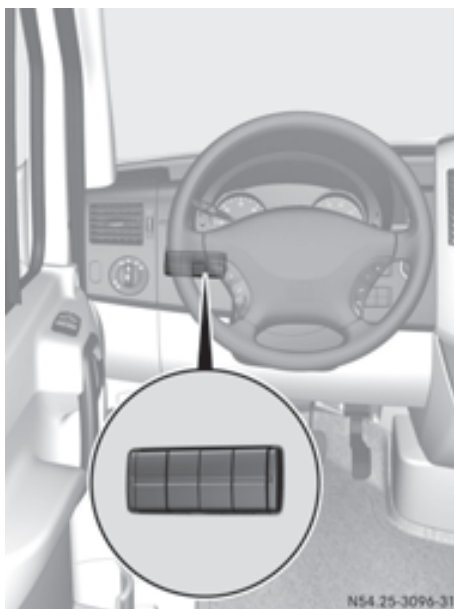

Switch unit between the light switch and the steering wheel

**Function**

- |  |  |
|--|--|
|  | Switches the auxiliary heating on/off            |
|  | Switches the heater booster function on/off      |
|  | Sets the working speed                           |
|  | Switches the working speed governor (ADR) on/off |
|  | Ventilates the cargo compartment                 |



**Warning!**

Make sure that you read the Operator's Manual. You may otherwise fail to recognize hazards.



Switch unit between the steering wheel and ignition lock

Function	
	Switches the rear-compartment convenience lighting on/off
	



**Warning!**

Make sure that you read the Operator's Manual. You may otherwise fail to recognize hazards.

## Opening and closing

### Remote control with an integrated folding key

The vehicle comes equipped with 2 or 4 remote controls with an integrated folding key.

The key's remote control conforms to the FCC regulations (part 15) and the Canadian Industrial Standard RSS-210 and has a range of up to 32 ft (10 m).



Remote control with an integrated folding key

- ① To unlock the sliding doors and the rear door
- ② To lock the driver's door only or the vehicle centrally
- ③ To lock the vehicle centrally
- ④ Key release button
- ⑤ Battery check lamp

► **To unlock the driver's door:** press the button.

The turn signals flash once. The anti-theft alarm system (ATA) is deactivated.

► **To unlock the sliding doors and rear door:** press the button.

The turn signals flash once.

► **To unlock centrally:** unlock the driver's door.

► Press the unlocking button again within two seconds.  
The turn signals flash once.

❗ **Cargo Vans and Passenger Vans only:** if you unlock the vehicle using the remote control and do not open a door within 40 seconds, the vehicle is automatically relocked.

► **To lock centrally:** press the locking button.

The turn signals flash three times when the drive authorization system or the Anti-Theft Alarm system (ATA) is activated and all the doors are closed.

❗ Make sure that the locking knobs have dropped down.

You can find further information in the "Controls" section of the vehicle's Operator's Manual.

## Adjusting

### Ignition lock

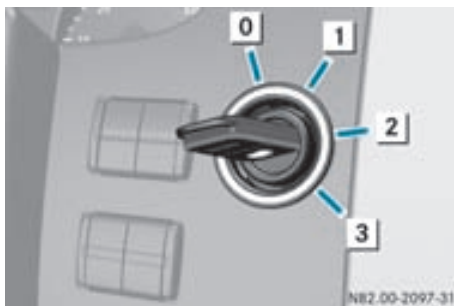

① To insert/remove the key, to lock the steering wheel

② To unlock the steering wheel, power supply for some consumers (e.g. the radio)

③ To switch on the ignition, power supply for all consumers preglow and drive position

④ To start the engine

❗ To unlock the steering wheel, move the steering wheel slightly while turning the key to position 1.



**Warning!**

Make sure that you read the Operator's Manual. You may otherwise fail to recognize hazards.

On vehicles with a battery isolating switch, you must first switch on the electrical system.

You can find information on the battery isolating switch in the "Controls" section of the vehicle's Operator's Manual.

### Seats

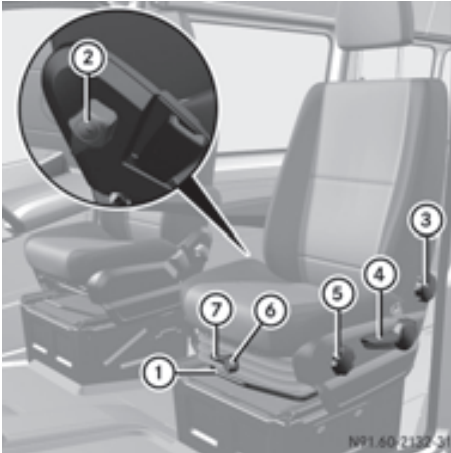

- ① Seat fore-and-aft adjustment
- ② Lumbar support adjustment
- ③ Seat backrest adjustment
- ④ Seat height adjustment
- ⑤ Seat cushion angle adjustment
- ⑥ Seat suspension adjustment
- ⑦ Seat suspension lock

**i** Depending on the seat model, some adjustments may not be available.

You can find further information in the "Controls" section of the vehicle's Operator's Manual.

### Steering wheel

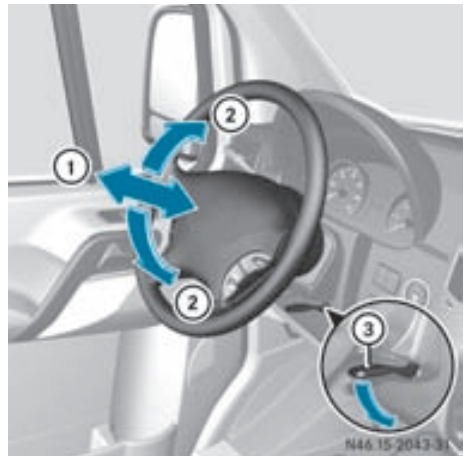

- ① Steering column fore-and-aft adjustment
- ② Steering column height
- ③ Lever

You can find further information in the "Controls" section of the vehicle's Operator's Manual.



**Warning!**

Make sure that you read the Operator's Manual. You may otherwise fail to recognize hazards.

## Seat belts

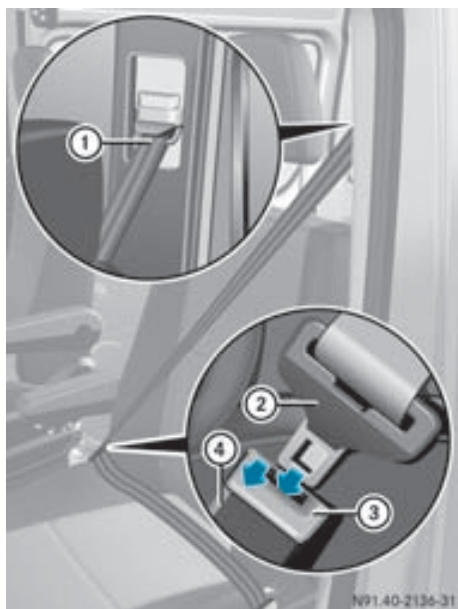

- ① Belt sash guide
- ② Belt tongue
- ③ Release button
- ④ Buckle

You can find further information in the "Safety" section of the vehicle's Operating Instructions.

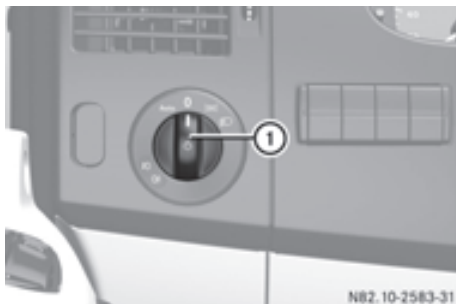

## Lighting

## Light switch



- ① Light switch

The symbols on the light switch have the following meanings:

- AUTO** Automatic headlamp mode
- 0** Lights off/daytime running lamp mode
-  Standing lamps, license plate lamp and instrument lighting on
-  Low-beam/high-beam headlamps (depending on the position of the combination switch)

You can find further information in the "Controls" section of the vehicle's Operating Instructions.

## Turn signals

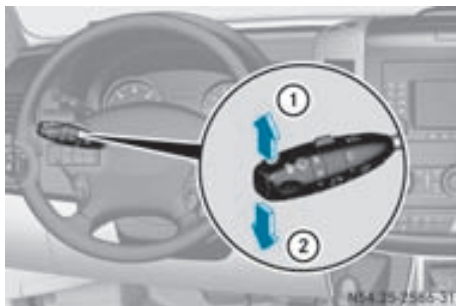

Combination switch

- ① To indicate a right turn
- ② To indicate a left turn



**Warning!**

Make sure that you read the Operator's Manual. You may otherwise fail to recognize hazards.

You can find further information in the "Controls" section of the vehicle's Operating Instructions.

## Good visibility

### Windshield wipers

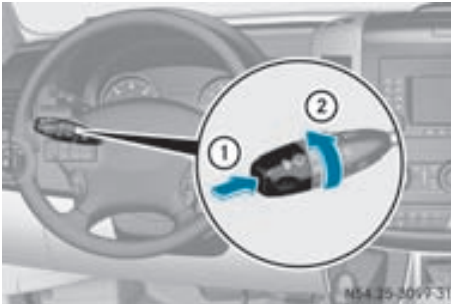

- ① Single wipe/to wipe with washer fluid
- ② To switch on the windshield wipers

The detent positions of the combination switch correspond to the following wiper speeds:

- 0 Windshield wipers off
- I Intermittent wipe
- II Normal wipe
- III Rapid wipe

You can find further information (including vehicles with a rain/light sensor) in the "Controls" section of your vehicle's Operating Instructions.

### Rear window wiper

The rear window wiper switches on automatically if you engage reverse gear and the windshield wipers are on.

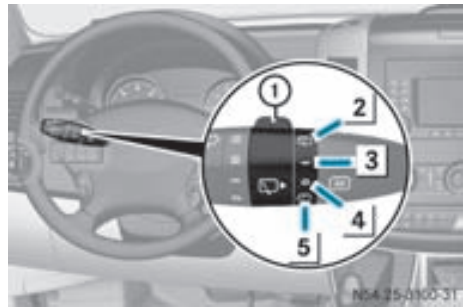

- ① Switch
- ② To wipe with washer fluid
- ③ Intermittent wipe
- ④ To switch off the wiper
- ⑤ To wipe with washer fluid

You can find further information in the "Controls" section of the vehicle's Operating Instructions.



**Warning!**

Make sure that you read the Operator's Manual. You may otherwise fail to recognize hazards.

## Climate control

### Overview of climate control systems

The vehicle is equipped with one of the following climate control systems:

#### Heating



N83.20-2255-31

The heating system is a heating and ventilation system without a cooling system.

#### Air-conditioning system



N83.25-2061-31

The air-conditioning system is a combination of a heating and ventilation system, together with a cooling system.

#### Rear-compartment heating



N83.20-2256-31

The separately activated rear-compartment heating allows a separate temperature and airflow setting for the rear compartment.

#### Rear-compartment air-conditioning system



N83.60-2023-31

The separately activated rear-compartment air-conditioning system allows a separate temperature and airflow setting for the rear compartment.

On vehicles without rear-compartment climate control, the control panel is equipped with a paper holder.



**Warning!**

Make sure that you read the Operator's Manual. You may otherwise fail to recognize hazards.



## Overview of the functions of the climate control system

### Heating

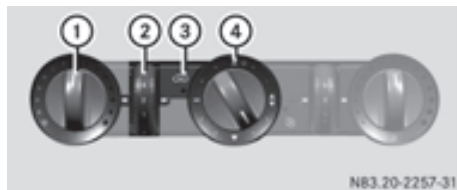

Operation	
①	Sets the temperature Defrosts the windshield
②	Sets the airflow Defrosts the windshield
③	Switches air-recirculation mode on/off
④	Sets the air distribution Defrosts the windshield

Recommendations for optimum climate control:

- Set the temperature control to the middle level. Only change the temperature in small increments.
- Only use the defrosting function until the windshield is clear again.
- Only use air-recirculation mode briefly, e.g. in a tunnel. The windows could otherwise fog up, because the flow of fresh air is cut off and the air inside the vehicle is circulated.

### Rear-compartment heating

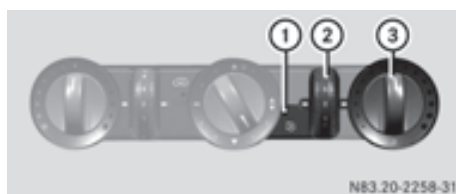

Operation	
①	Switches the rear-compartment heating on/off
②	Sets the airflow
③	Sets the temperature

For optimum climate control, set the temperature control to the middle level. Only change the temperature in small increments.

### Air-conditioning system

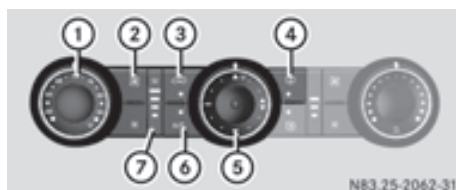



Operation	
①	Sets the temperature Defrosts the windshield
②	Sets the airflow Increases the airflow Decreases the airflow
③	Switches air-recirculation mode on/off
④	Switches the reheat function (window air dehumidification) on/off
⑤	Sets the air distribution



**Warning!**

Make sure that you read the Operator's Manual. You may otherwise fail to recognize hazards.



	Operation
	 Defrosts the windshield
⑥	 Switches cooling with air dehumidification on/off
⑦	Blower setting bar display
	 Defrosts the windshield

Recommendations for optimum climate control:

- Set the temperature to 72 °F (22 °C) . Only change the temperature in small increments.
- Switch on cooling with air dehumidification. The indicator lamp in the switch comes on.
- Only use the defrosting function until the windshield is clear again.
- Only use the reheat function until the fogged up windows are clear again.
- Only use air-recirculation mode briefly, e.g. in a tunnel. The windows could otherwise fog up, because the flow of fresh air is cut off and the air inside the vehicle is circulated.

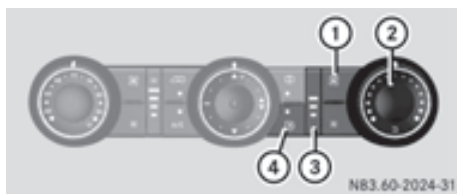
### Rear-compartment air-conditioning system





	Operation
①	Sets the airflow
	 Increases the airflow
	 Decreases the airflow
②	Sets the temperature



**Warning!**

Make sure that you read the Operator's Manual. You may otherwise fail to recognize hazards.

	Operation
③	 Blower setting bar display
④	 Switches the rear-compartment air conditioning on/off



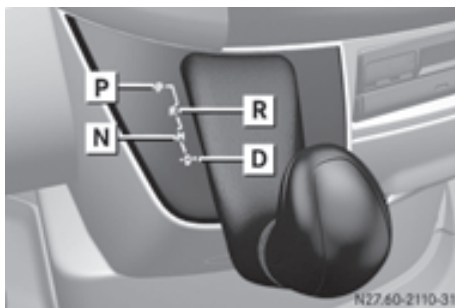

For optimum climate control, set the temperature control to the middle level. Only change the temperature in small increments. You can find further information on air conditioning in the "Controls" section of the vehicle's Operating Instructions.

### Driving

#### Automatic transmission



Gearshift pattern

-  Park position with selector lever lock
-  Reverse gear
-  Neutral
-  Drive

You can find further information in the "Controls" section of your vehicle's Operator's Manual.

## Parking brake

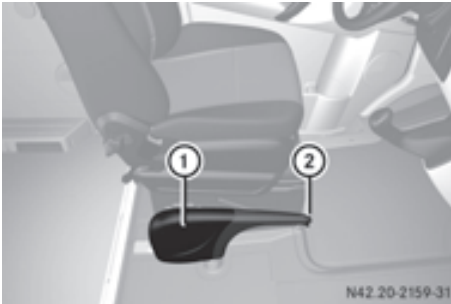

- ① Brake lever
- ② Release knob

**i** Only apply the parking brake when the vehicle is stationary.

You can find further information in the "Controls" section of your vehicle's Operator's Manual.



**Warning!**

Make sure that you read the Operator's Manual. You may otherwise fail to recognize hazards.

## Refueling

The fuel filler flap is beside the front left-hand door when viewed in the direction of travel. It is only possible to open the fuel filler flap when the front door is open.

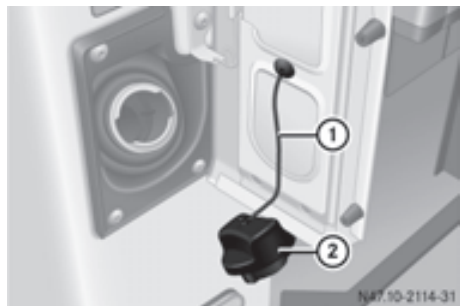

- ① Retaining strap
- ② Fuel filler cap

**!** Filter the fuel before transferring it to the vehicle if you are refueling the vehicle from barrels or containers.

This will prevent malfunctions in the fuel system due to contaminated fuel.

**!** Do not use gasoline to refuel vehicles with a diesel engine. Do not use diesel to refuel vehicles with a gasoline engine. Even small amounts of the wrong fuel result in damage to the injection system and the engine. Damage resulting from adding the wrong fuel is not covered by the Limited Warranty.

**!** Do not start the engine if you accidentally refuel with the wrong fuel. Otherwise, the fuel could enter the fuel lines. This would require draining of the fuel tank and fuel lines. Notify a qualified specialist workshop and have the fuel tank and fuel lines drained completely.

You will find information about fuel in the "Technical data" and "Operation" sections of the vehicle's Operator's Manual.

## Diesel Exhaust Fluid (DEF)

**!** Only use DEF in accordance with ISO 22241. Never mix DEF with additives or thin it with tap water. The exhaust gas aftertreatment may otherwise be damaged.

Observe the MB Specifications for Service Products, Sheet 352.0.

Damage that results from the use of additives or tap water leads to a loss of Limited Warranty entitlements.

**!** If DEF comes into contact with a painted or aluminum surface, wash the surface off immediately with plenty of water.

**!** DEF is not a diesel additive and must not be mixed with fuel in the tank. Even small amounts of DEF can cause engine damage. Damage resulting from adding DEF is not covered by the New Vehicle Limited Warranty.

**i** Do not inhale any ammonia vapors which may escape when you unscrew the tank filler cap. Ammonia vapors have a pungent odor. However, they are neither toxic nor hazardous to health in this concentration.

## DEF filler neck in the engine compartment



- ① Fuel filler neck cover



**Warning!**

Make sure that you read the Operator's Manual. You may otherwise fail to recognize hazards.

## DEF filler neck on the right-hand vehicle side

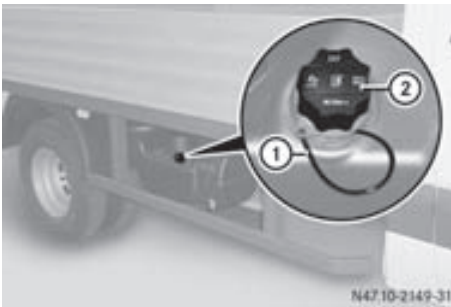

DEF tank on the right-hand side of the vehicle  
(example: Cab Chassis)

- ① Retaining strap
- ② Fuel filler neck cover

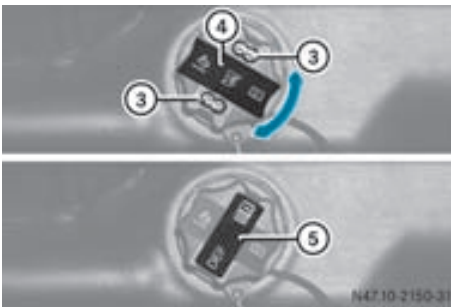

DEF tank filler cap

- ③ Holes under the cover for the release tool
- ④ Cover
- ⑤ Filler cap release tool

You will find information about Diesel Exhaust Fluid (DEF) in the "Technical data" and "Operation" sections of the vehicle's Operator's Manual.



Make sure that you read the Operator's Manual. You may otherwise fail to recognize hazards.

## Where will I find...?

### Vehicle tool kit and emergency equipment

The jack and the vehicle tool kit are located in the co-driver's footwell.

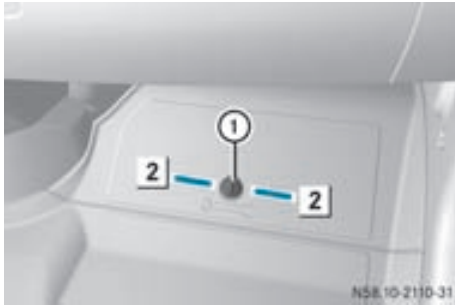

- ① Quick-release fastener
- ② Unlocked

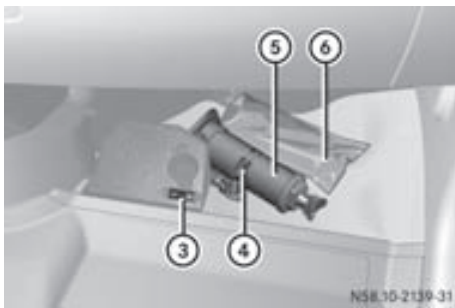

- ③ Tool<sup>1</sup> for DEF filler cap
- ④ Quick-release lever
- ⑤ Jack
- ⑥ Vehicle tool kit

You will find further information in the "Practical advice" section of the vehicle's Operating Instructions.

### Warning triangle

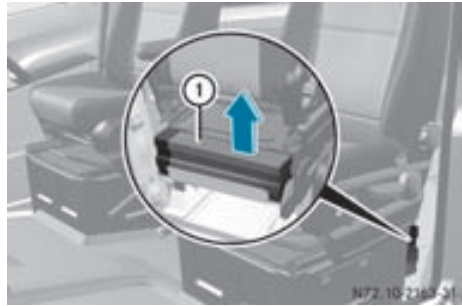

Warning triangles at the back of the driver's seat base

- ① Warning triangles

### Warning lamp

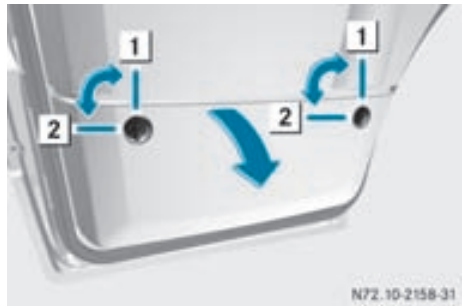

- ① Locked
- ② Unlocked

<sup>1</sup> Cab Chassis only.



Make sure that you read the Operator's Manual. You may otherwise fail to recognize hazards.



N72.10-2165-31

The warning lamp is behind the cover in the storage compartment of the driver's door.

- ③ Warning lamp

### First-aid kit

The first-aid kit is located in the stowage compartment in the co-driver's door.

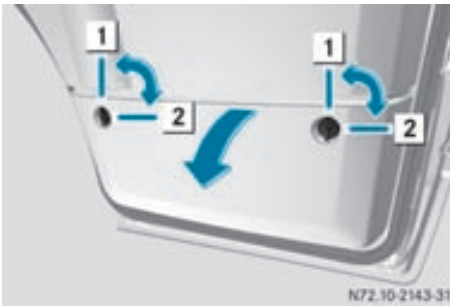

N72.10-2143-31

- ① Locked  
② Unlocked



N72.10-2144-31

- ③ First-aid kit

- ① Check the expiration date of the first-aid kit annually, and replace the contents when necessary.

### Spare wheel

The spare wheel is located in a spare wheel bracket under the rear of the vehicle.

### Cargo Van/Passenger Van

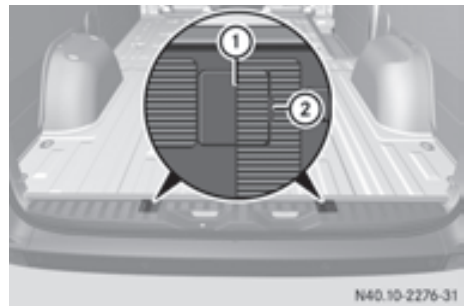

N40.10-2276-31

- ① Cover  
② Recess

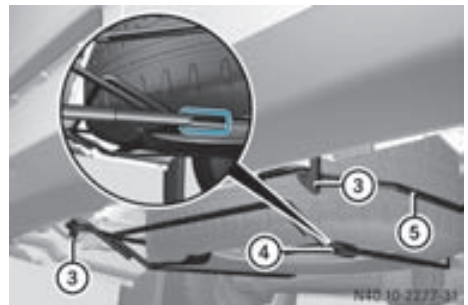

N40.10-2277-31

- ③ Safety catch  
④ Sleeve  
⑤ Spare wheel bracket



**Warning!**

Make sure that you read the Operator's Manual. You may otherwise fail to recognize hazards.

### Cab Chassis

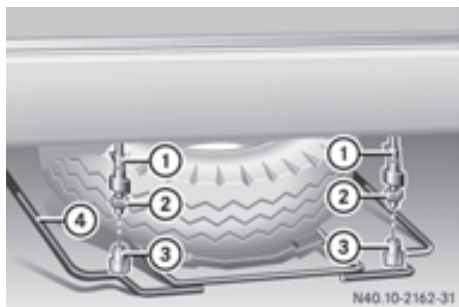

- ① Safety catch
- ② Nuts
- ③ Wing nuts
- ④ Spare wheel bracket

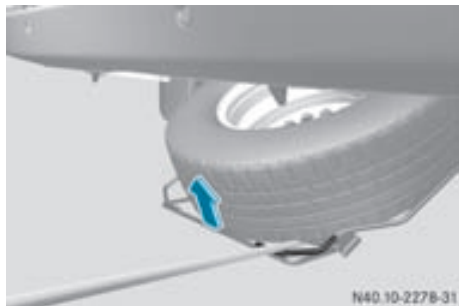

- i** You can raise the spare wheel bracket or lower it to the ground using the jack pump lever as shown.

For further information, please consult the "Practical advice" section of the Operator's Manual.

### Tire sealant

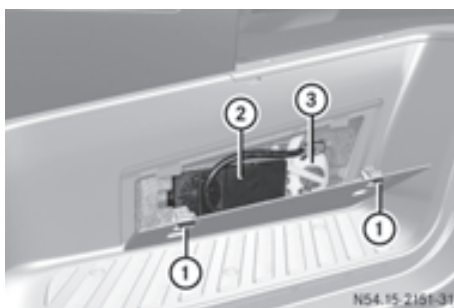

Tire sealant in the stowage compartment in the right-hand door sill

- ① Latching springs
- ② Electric air pump
- ③ Premium tire sealant

For further information concerning the tire repair kit, please consult the "Practical advice" section of the Operator's Manual.



**Warning!**

Make sure that you read the Operator's Manual. You may otherwise fail to recognize hazards.







## **Impressum**

### **Internet**

Further information about Freightliner Vans can be found on the following website:

[www.freightlinersprinterusa.com](http://www.freightlinersprinterusa.com)

### **Editorial office**

You are welcome to forward any queries or suggestions you may have regarding this manual to the technical documentation team at the following address:

Daimler Vans USA, LLC

One Mercedes Drive

Montvale, NJ 07645-0350

[www.freightlinersprinterusa.com](http://www.freightlinersprinterusa.com)

Customer Assistance Center:

1-877-762-8267

© Daimler Vans USA, LLC

Daimler Vans USA, LLC is a Daimler company.

Not to be reprinted, translated or otherwise reproduced, in whole or in part, without written permission.

Printed in U.S.A

Press date: August 1, 2010



9065845871

Order no. 6462 7474 13 Part no. 906 584 58 71 Edition B MY 2011 FTL